

Countertop models* with integral air-cooled icemaker

7CI100A – 115 V, 60 Hz, push button

Freestanding models* with integral air-cooled icemaker

7FS100A – 115 V, 60 Hz, push button

* Must specify ice-only or ice and water dispensing.

Note

For use in applications with less than 400 mg/l total dissolved solids in water and less than 200 mg/l hardness (either naturally occurring or treated with reverse osmosis or other TDS reducing technology).

Not recommended for use with softened water.



7CI100A (countertop)



7FS100A (freestanding)

Countertop and freestanding ice-only or ice and water dispensers with integral air-cooled icemaker. Produces and automatically loads up to 125 lbs (57 kg) of Chewblet compressed nugget ice in a 24-hour period. Storage capacity of 7 lbs (3 kg). Designed to serve up to 25 people. The 7 Series can supply up to 140 servings (16 oz cups 2/3 full of ice) per day. Requires water with less than 400 mg/l (ppm) dissolved solids.

Attractive, space-saving design

- Narrow 14.6" (371 mm) width and 22" (559 mm) depth fits on standard counters
- Low profile 17.5" (445 mm) height fits on counters under standard cabinets
- Freestanding models include a base cabinet
- Attractive, modern styling, high-quality stainless exterior with decorative plastic trim and soft, blue LED lighting of dispense area
- Capacitive touch user interface

Maximum placement flexibility

- Drainless design allows dispenser to be placed anywhere a water line can be run and eliminates cost of drain installation
- Top of dispenser can hold 35 lbs (16 kg), enough for a coffee brewer

Chewblet ice – the ice that people like

- Soft, chewable compressed nugget ice
- Preferred over cube-type ice by over 2:1**
- Accepts cups up to 8.5" (216 mm) tall

Sanitation and safety

- Agion® antimicrobial product protection*** in key ice and water contact components
- Sanitary, dispensing of ice to reduce chances of contamination
- Leak detection in icemaking module
- Large, 20 oz capacity, easy-to-empty drip tray
- Optional internal water filtration

Easy to clean and maintain

- Automatic alert to empty drip tray
- Easy cleaning of ice machine and bin
- Easy troubleshooting via user interface and diagnostic circuit board

Environmentally responsible

- State-of-the-art icemaker uses R-134a refrigerant
- Energy and water efficient, energy saving sleep mode

Warranty

- 2 years parts and labor, 5 years compressor parts
- Optional 3rd year parts and labor warranty (Item# 00960732)

Accessories

- 4" (102 mm) leg kit for countertop models (item# 00956300)
- 6" (153 mm) leg kit for freestanding models (item# 00956318)
- Drain kit to connect drip tray to a drain for CI model (item# 00981977)
- Drain kit to connect drip tray to a drain for FS model (item# 00956375)
- Internally mounted 5 micron particle and carbon water filtration system (item# 00958223)
- Water filter replacement cartridge (5 micron) (item# 00968107)
- SafeCLEAN™ environmentally responsible icemaker cleaner
 - Case of (24) 7 oz packets (item# 00132001)
 - 7 oz single packet (item# 00926030)
- Nu-Calgon**** IMS-II icemaker sanitizer, 16 oz bottle (item# 00979674)
- Single use cleaning/sanitizing kit (item# 00979856)
- Claris***** hardness removal filtration system (item# 00986059)
- Reverse osmosis system, 200 gallons per day (item# 00986034)

** Independent third party studies. Contact Follett for details.

*** Disclaimer: Antimicrobial protection is limited to the treated components and does not treat water or ice.

**** Calgon is a licensed tradename distributed by Nu-Calgon, in the United States.

***** Claris is a registered trademark of the Aquis GmbH in Switzerland.

Agion is a registered trademark of Agion Technologies Inc., Wakefield, MA, USA.

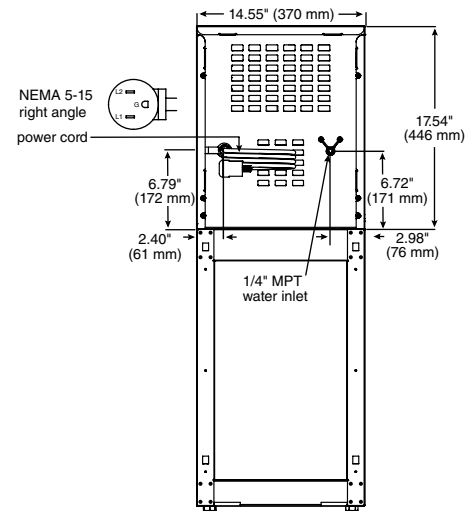
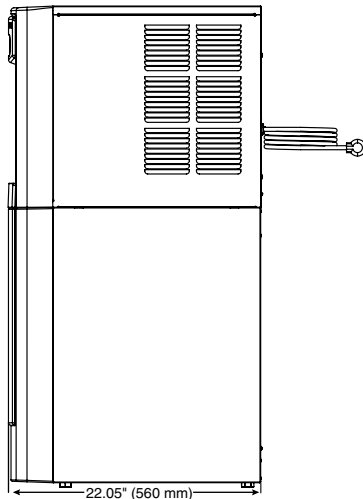
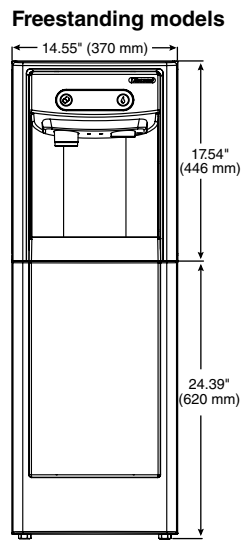
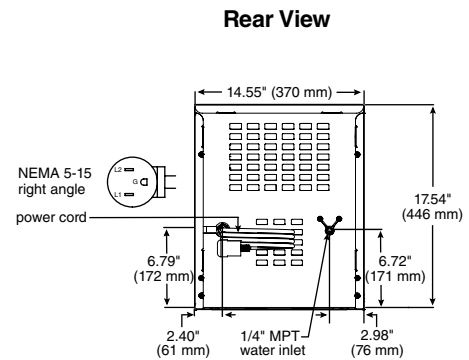
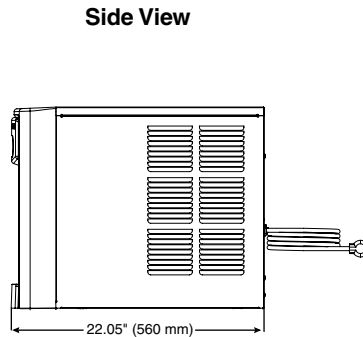
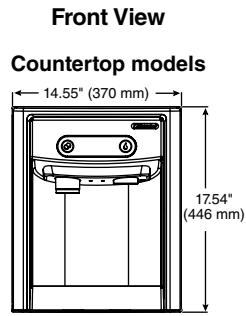

Notes

For indoor use only.
Designed for commercial use. Follett is not able to provide in-house services for residential installations.

Operating limits

Ambient air temp. range – 50 F to 100 F (10 C to 38 C).
Water temp. range – 40 F to 90 F (4 C to 32 C).
Water pressure – 10 psi to 70 psi (69 kpa to 483 kpa).

Clearances

	Countertop and Freestanding
Required for ventilation	3" (76 mm) each side

Electrical

115 V, 60 Hz, 1 phase, 5 amps. Connect to dedicated 15 amp circuit, fuse or breaker. **Note:** It is preferred that circuit be protected by a GFCI.

8 ft (2.4 m) cord and NEMA 5-15 right angle plug provided with each dispenser.
If local code requires hard-wiring, separate disconnects also required.

Approximate shipping weight

7C100A – 90 lbs (43 kg)
7FS100A – 120 lbs (55 kg)

Specifications (Choose one) Ice and water ____ or ice-only ____ dispenser to be Follett automatic load in (choose one) ____ countertop or ____ freestanding configuration, with 7 lbs (3 kg) of storage. Environmentally responsible R-134a icemaker to be air-cooled. Icemaker to produce approximately 125 lbs (57 kg) of Chewblet compressed nugget ice at air temperature of 70 F (21 C) and water temperature of 50 F (10 C). Icemaker to be equipped with printed circuit board and diagnostics to allow simplified servicing and with capacitive touch user interface. Storage area to be insulated with non-CFC, high density foam-in-place polyurethane. 115 V, 60 Hz, 1 phase. 8 ft cord and NEMA 5-15 right angle plug provided. Dispenser to be ETL and NSF listed. Total dissolved solids in water not to exceed 400 mg/l (ppm).

SafeCLEAN is a trademark of Follett Corporation.
Chewblet and Follett are registered trademarks of Follett Corporation, registered in the US.
Follett reserves the right to change specifications at any time without obligation. Certifications may vary depending on country of origin.

Energy consumption

KWH per 100 lbs (45.4 kg) ice†	
Air-cooled	6.9

† Air temp. 90 F (32 C); water temp. 70 F (21 C)

Heat rejection 1700 BTU/hr

Water consumption 12 gal (45.4 L) of potable water usage per 100 lbs (45.4 kg) of ice.

Ice production

125 lbs (56.8 kg) at 70 F (21 C) air and 50 F (10 C) water.
100 lbs (45.4 kg) at 90 F (32 C) air and 70 F (21 C) water.